

Name: _____

Number the steps (1-5) for writing and mailing a letter.

National HANDWRITING Day

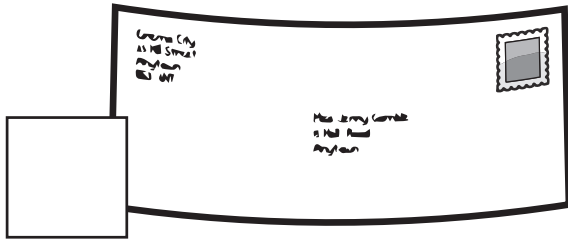

Address the envelope and put a stamp on it.



Mail your letter.

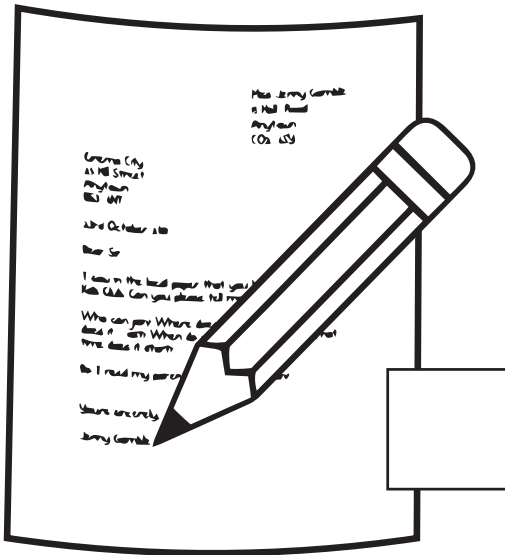

Write your letter.

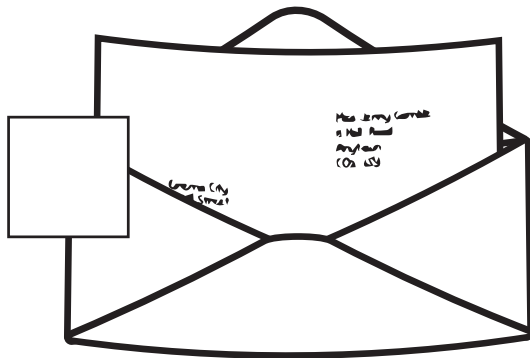

Put your letter in an envelope.

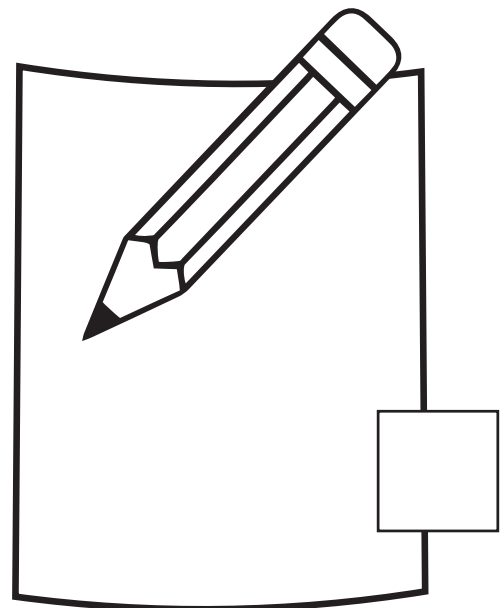

Gather your supplies.

Name: _____

National
HANDWRITING
Day

Writing a letter is a wonderful way to let people know you're thinking of them! In the bubbles below, write the names of people you think would like to receive a letter. Then, pick one person to write a letter to. Use the writing lines on the next page to write your letter.

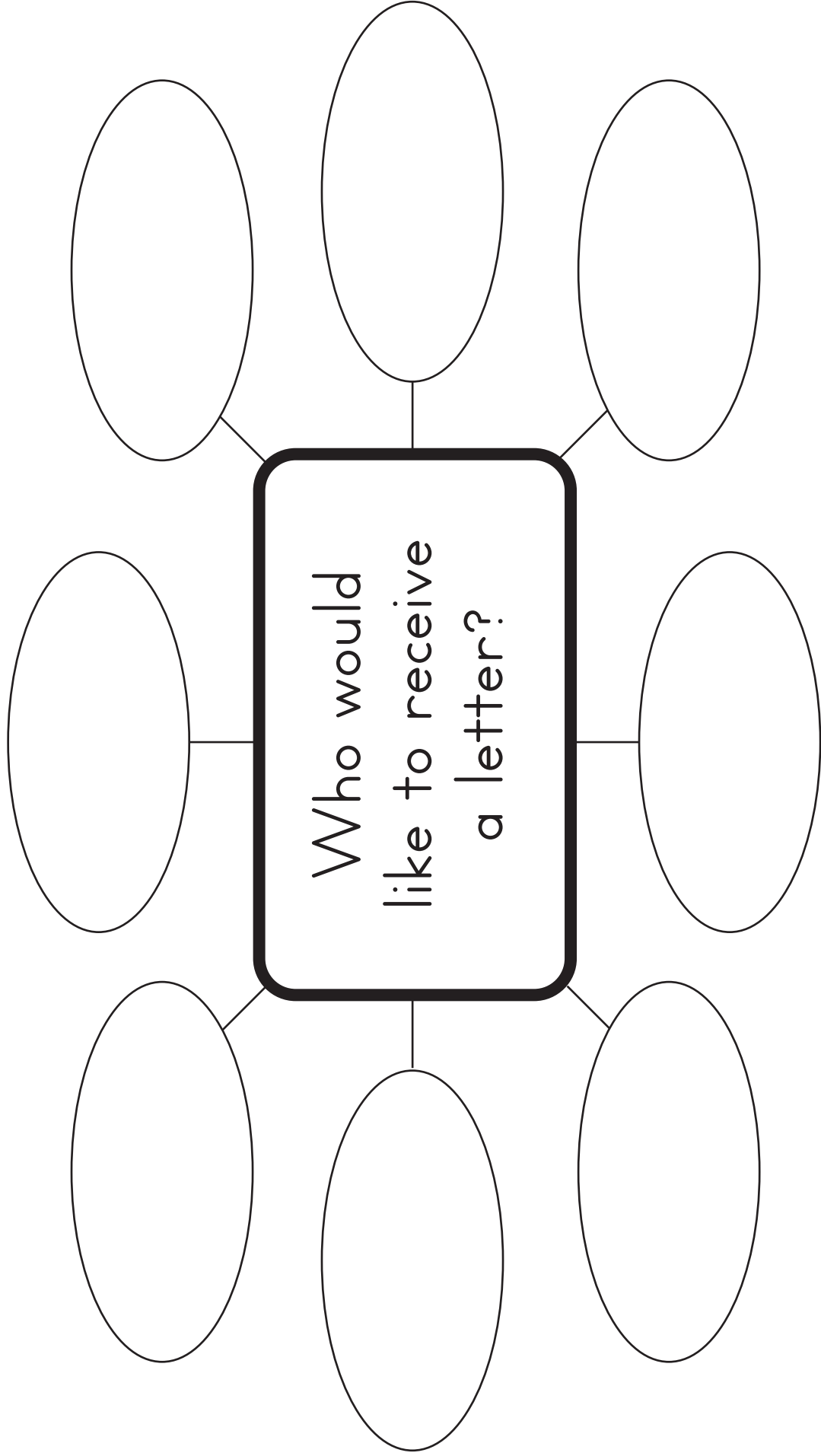

Dear

Sincerely,

Dear

Sincerely,

Dear

Sincerely,

Name: _____

Color and cut out each shape. Glue each piece in the correct space on the right to make a pencil.

National
HANDWRITING
Day 

Rectangle (Yellow)



Square (Pink)

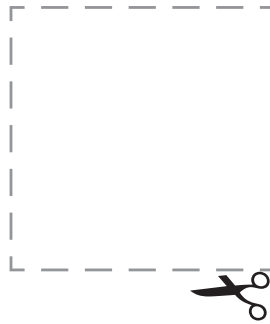

Trapezoid (Brown)

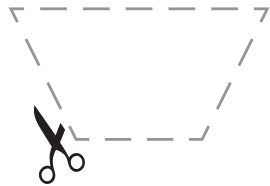

Triangle (Black)

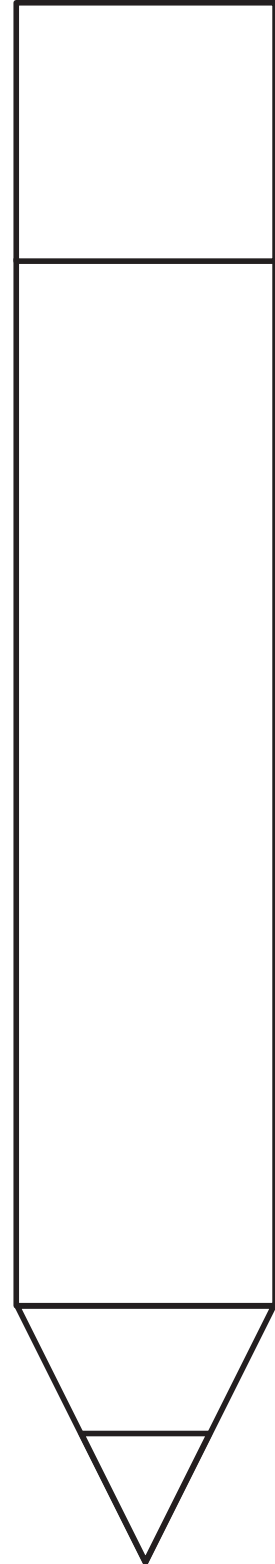

Name: _____

Trace the words. Match the writing tool with what it is used on.

National HANDWRITING Day

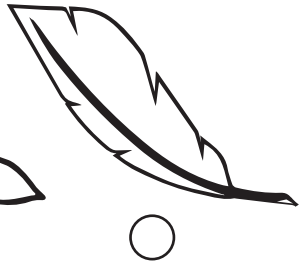
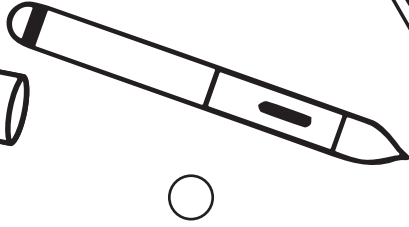
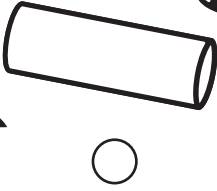
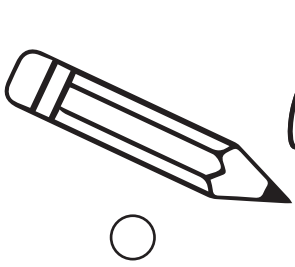
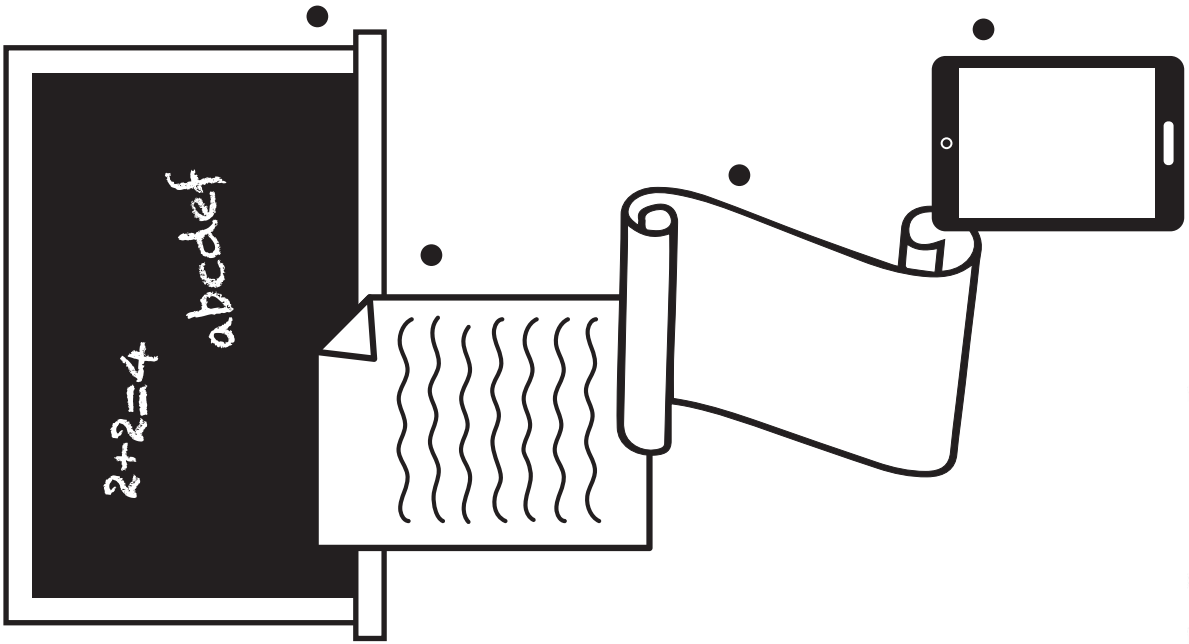

Pencil

Chalk

Stylus

Quill

Name: _____

Find the letters in the word "HANDWRITING"
in the picture.

National
HANDWRITING
Day 



Can you spot these letters in the picture?

HANDWRITING

Name: _____

National
HANDWRITING
Day 

Find the letters in the word "HANDWRITING"
in the picture.

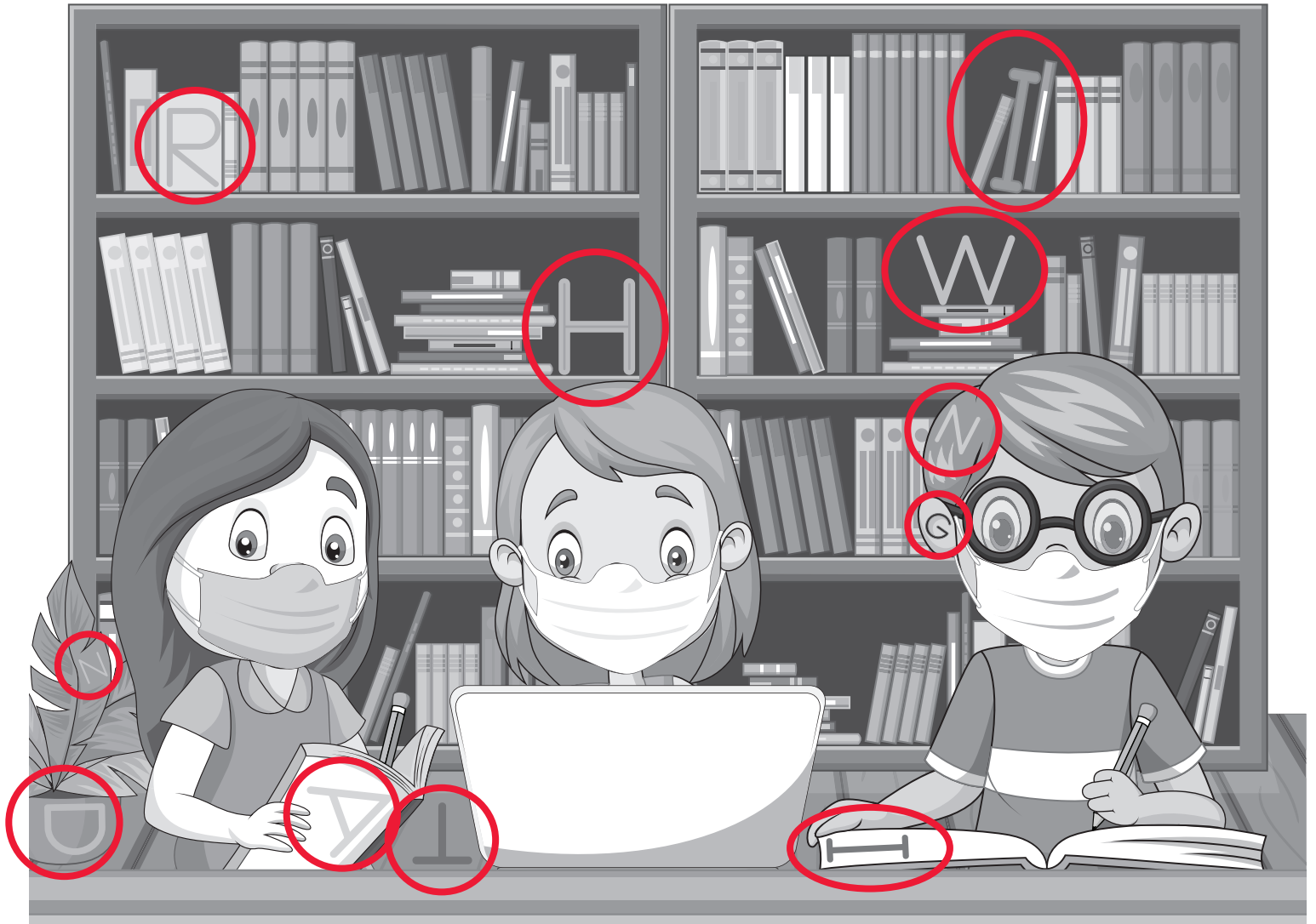

Can you spot these letters in the picture?

HANDWRITING

Name: _____

Draw a self-portrait. Then, write your signature.

National
HANDWRITING
Day 

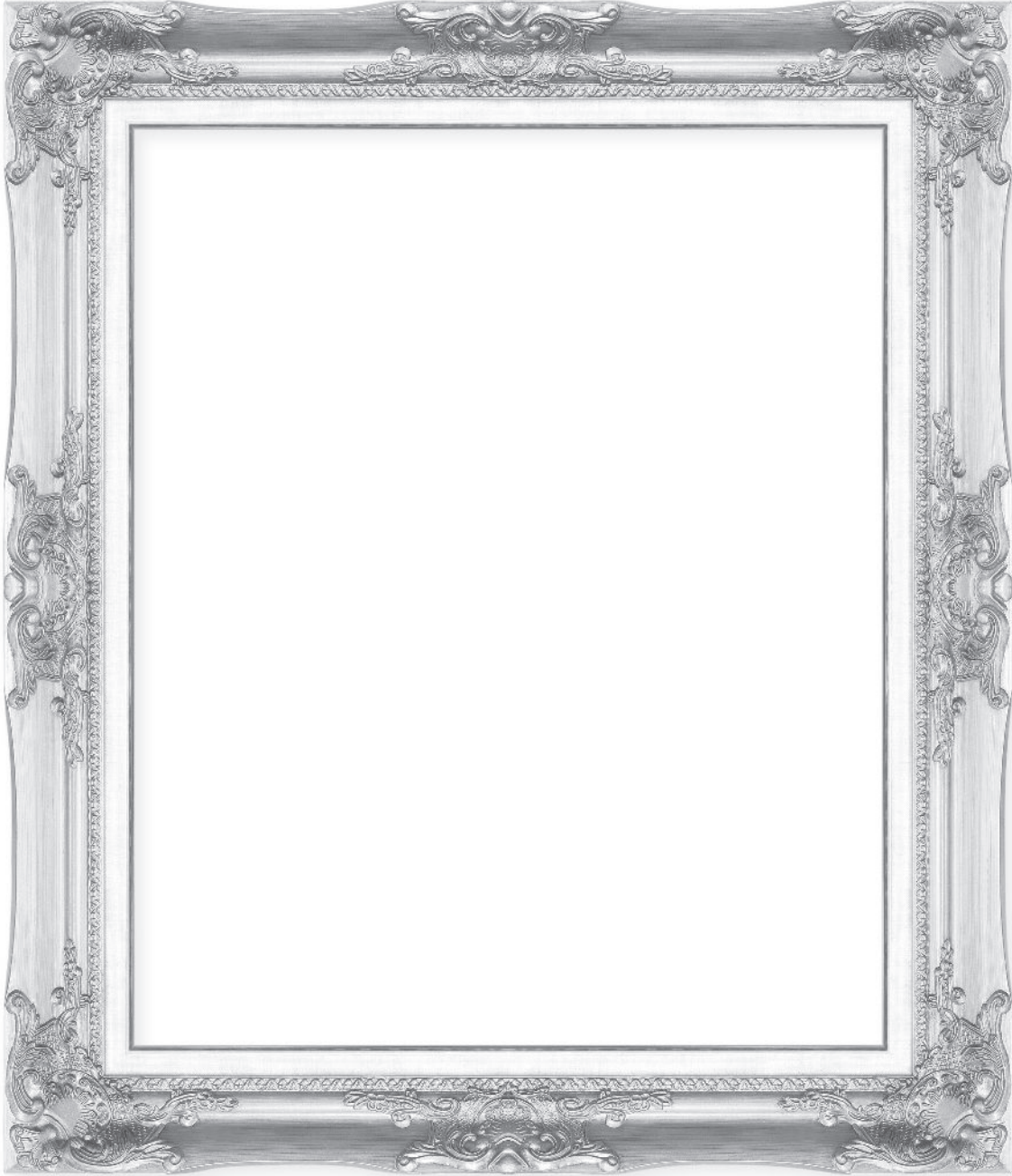

Sign your name.

Name: _____

Color the picture.

National
HANDWRITING
Day 



Handwriting

Name: _____

National
HANDWRITING
Day 

Find the words below in the box.
Cross off the words as you find them.

M	P	E	N	C	I	L	J
G	P	Z	Q	A	L	A	V
G	Y	L	I	N	E	S	S
H	F	G	P	P	T	I	P
U	J	B	X	P	T	G	L
D	W	R	I	T	E	Z	F
F	P	A	P	E	R	P	P
W	O	R	D	S	L	H	C

- LETTER
- WRITE
- PAPER
- WORDS
- PENCIL
- LINES

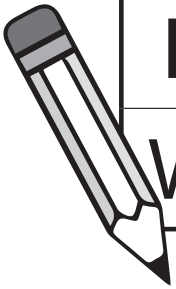

Trace the words.

Letter --- Write
Paper --- Words
Pencil --- Lines

Name: _____

National
HANDWRITING
Day 

Find the words below in the box.
Cross off the words as you find them.

L	J	M	S	T	B	G	O	U	N	T	A	B	G	K	B	B	P	T	R
W	O	B	P	H	S	G	S	X	S	F	F	L	D	S	A	I	D	Y	U
Y	H	H	C	Y	N	A	R	K	B	H	C	I	D	E	S	L	P	M	G
W	N	T	G	O	A	T	V	T	O	V	B	A	S	N	I	S	A	Q	J
A	H	A	N	D	W	R	I	T	I	N	G	R	I	T	C	M	R	P	R
J	A	C	U	R	S	I	V	E	S	T	M	G	G	E	S	O	A	L	W
J	N	C	F	Z	F	Q	D	X	H	V	W	X	N	N	T	K	G	J	B
V	C	U	P	P	E	R	C	A	S	E	M	K	M	C	R	O	R	X	K
L	O	W	E	R	C	A	S	E	O	N	I	N	S	E	O	N	A	E	T
C	C	I	C	U	T	H	A	Y	U	W	O	R	D	S	K	A	P	F	B
T	K	B	U	O	X	O	V	P	F	A	U	P	H	E	E	C	H	D	A
S	C	M	A	N	U	S	C	R	I	P	T	E	P	A	S	J	S	P	O
K	N	A	T	I	O	N	A	L	R	Z	Y	P	D	T	R	F	L	J	K
T	F	C	I	X	E	D	G	W	I	K	X	K	E	I	Y	K	Z	N	O
H	L	E	T	T	E	R	S	X	Z	B	S	V	Y	M	C	Y	D	G	V
C	N	A	P	Q	M	B	F	A	M	K	W	W	I	U	T	Y	M	Z	E
R	P	W	A	Q	X	A	U	Y	S	H	Z	Q	F	C	C	U	F	L	W
L	H	O	P	E	G	D	W	S	I	S	N	O	Z	F	R	L	E	I	A
D	M	Z	E	Z	P	V	B	I	R	T	H	D	A	Y	J	Y	U	Q	V
P	Q	T	R	W	H	B	L	D	P	E	N	C	I	L	Q	Z	A	I	L

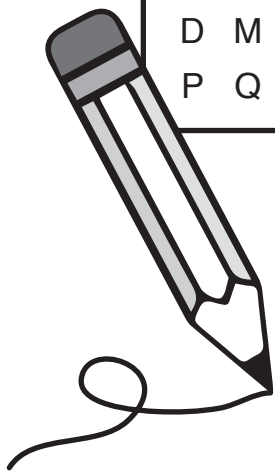

**National
Handwriting
John Hancock
Birthday
Pencil**

**Paper
Cursive
Manuscript
Uppercase
Lowercase**

**Basic Strokes
Words
Letters
Sentences
Paragraphs**

ANSWER KEY

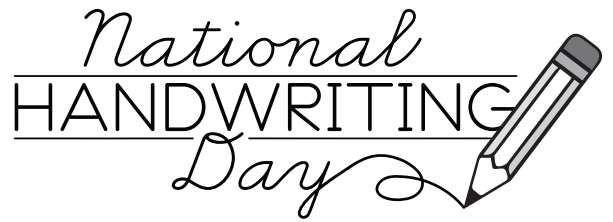

Find the words below in the box.
Cross off the words as you find them.

L	J	M	S	T	B	G	O	U	N	T	A	B	G	K	B	B	P	T	R
W	O	B	P	H	S	G	S	X	S	F	F	L	D	S	A	I	D	Y	U
Y	H	H	C	Y	N	A	R	K	B	H	C	I	D	E	S	L	P	M	G
W	N	T	G	O	A	T	V	T	O	V	B	A	S	N	I	S	A	Q	J
A	H	A	N	D	W	R	I	T	I	N	G	R	I	T	C	M	R	P	R
J	A	M	U	D	S	I	N	E	S	T	M	G	G	E	S	O	A	L	W
J	N	C	F	Z	F	Q	D	X	H	V	W	X	N	N	T	K	G	J	B
V	C	U	P	P	E	R	C	A	S	E	M	K	M	C	R	O	R	X	K
L	O	W	E	R	C	A	S	E	O	N	I	N	S	E	O	N	A	E	T
C	C	I	C	U	T	H	A	Y	U	W	O	R	D	S	K	A	P	F	B
T	K	B	U	O	X	O	V	P	F	A	U	P	H	E	E	C	H	D	A
S	C	M	A	N	U	S	C	R	I	P	T	E	P	A	S	J	S	P	O
K	N	A	T	I	O	N	A	L	R	Z	Y	P	D	T	R	F	L	J	K
T	F	C	I	X	E	D	G	W	I	K	X	K	E	I	Y	K	Z	N	O
H	L	E	T	T	E	R	S	X	Z	B	S	V	Y	M	C	Y	D	G	V
C	N	A	P	Q	M	B	F	A	M	K	C	U	R	S	I	V	E	Z	E
R	P	W	A	Q	X	A	U	Y	S	H	Z	Q	F	C	C	U	F	L	W
L	H	O	P	E	G	D	W	S	I	S	N	O	Z	F	R	L	E	I	A
D	M	Z	E	Z	P	V	B	I	R	T	H	D	A	Y	J	Y	U	Q	V
P	Q	T	R	W	H	B	L	D	P	E	N	C	I	L	Q	Z	A	I	L

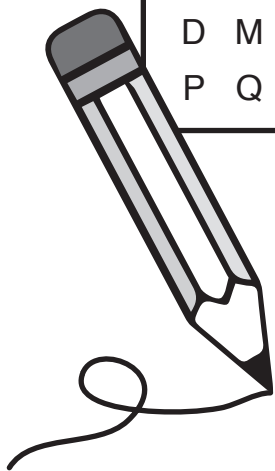

- | | | |
|---------------------|-------------------|----------------------|
| National | Paper | Basic Strokes |
| Handwriting | Cursive | Words |
| John Hancock | Manuscript | Letters |
| Birthday | Uppercase | Sentences |
| Pencil | Lowercase | Paragraphs |